

DS-2CE50DF3T-VPLFS 2MP Smart Hybrid Light ColorVu Fixed Dome Camera



- High quality imaging with 2 MP, 1920 × 1080 resolution
- 24/7 color imaging with F1.0 aperture
- Smart-Hybrid light, optimize your security with flexible lighting options
- Clear imaging against strong back light due to 130 dB true WDR technology
- 3D DNR technology delivers clean and sharp images
- 2.8 mm, 3.6 mm fixed focal lens
- Up to 40 m white light distance for bright night imaging
- Up to 40 m IR distance for bright night imaging
- High quality audio with audio over coaxial cable, built-in mic
- One port for four switchable signals (TVI/AHD/CVI/CVBS)
- Water and dust resistant (IP67) and vandal resistant (IK10)

▪ Specification

Camera	
Image Sensor	2 MP CMOS
Max. Resolution	1920 (H) × 1080 (V)
Slow Shutter	Max. 16 times
Min. Illumination	0.0005 Lux @ (F1.0, AGC ON), 0 Lux with white light
Day & Night	ICR
Angle Adjustment	Pan: 0 to 355°, Tilt: 0 to 75°, Rotation: 0 to 355°
Signal System	PAL/NTSC
Shutter Time	PAL: 1/25 s to 1/50,000 s; NTSC: 1/30 s to 1/50,000 s
Lens	
Lens Type	2.8 mm, 3.6 mm fixed focal lens
Focal Length & FOV	2.8 mm, horizontal FOV: 105°, vertical FOV: 56°, diagonal FOV: 123° 3.6 mm, horizontal FOV: 85°, vertical FOV: 46°, diagonal FOV: 98°
Lens Mount	M12
Illuminator	
Supplement Light Type	IR, White Light
Supplement Light Range	IR: Up to 40 m, White Light: Up to 40 m
Smart Supplement Light	Yes
Image	
Image Parameters Switch	STD/HIGH-SAT/HIGHLIGHT
Image Settings	Brightness, Contrast, Sharpness, Anti-banding, AGC
Frame Rate	TVI: 1080p @30 fps, 1080p @25 fps AHD: 1080p @30 fps, 1080p @25 fps CVI: 1080p @30 fps, 1080p @25 fps CVBS: PAL/NTSC
Day/Night Mode	Auto
Wide Dynamic Range (WDR)	≥130 dB
Image Enhancement	WDR, BLC, HLC, Global, HLS
Privacy Mask	4 programmable privacy masks
Noise Reduction	3D DNR
White Balance	Auto, Manual
Interface	
Video Output	Switchable TVI/AHD/CVI/CVBS
Alarm	Solid Light Alarm(White Light)

Built-in Microphone	Yes
Event	
Motion Detection	4 programmable motion areas
General	
Power	12 VDC \pm 25%, max.6.9 W,*You are recommended to use one power adapter to supply the power for one camera.
Material	Metal
Dimension	\varnothing 121.5 mm \times 97.6 mm (\varnothing 4.78" \times 3.84")
Weight	Approx. 510 g (1.12 lb.)
Operating Condition	-40 °C to 60 °C (-40 °F to 140 °F). Humidity 90% or less (non-condensing)
Communication	HIKVISION-C
Language	English
Approval	
Protection	IP67, IK10

▪ **Available Model**

DS-2CE50DF3T-VPLFS(2.8mm)

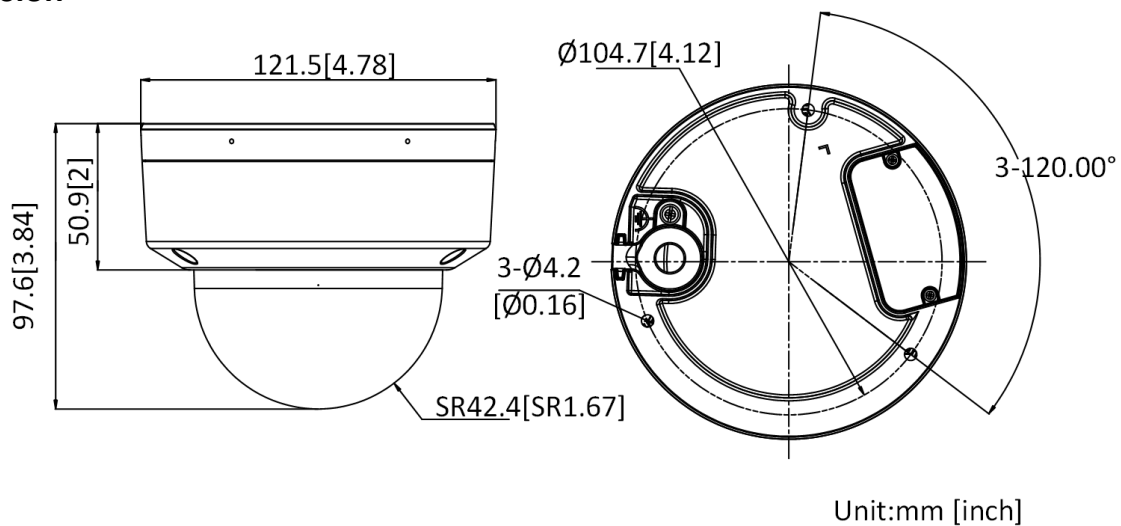

DS-2CE50DF3T-VPLFS(3.6mm)

▪ **Dimension**



▪ **Accessory**

▪ Optional

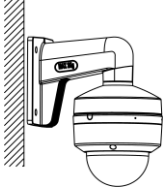
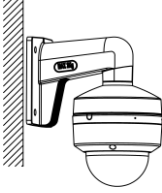
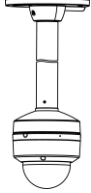
DS-1272ZJ-120 Wall mount	DS-1272ZJ-120B Wall mount	DS-1271ZJ-120 Pendant Mount
		
		

Headquarters

No.555 Qianmo Road, Binjiang District,
Hangzhou 310051, China
T +86-571-8807-5998
www.hikvision.com



Follow us on social media to get the latest product and solution information.

